

Godox

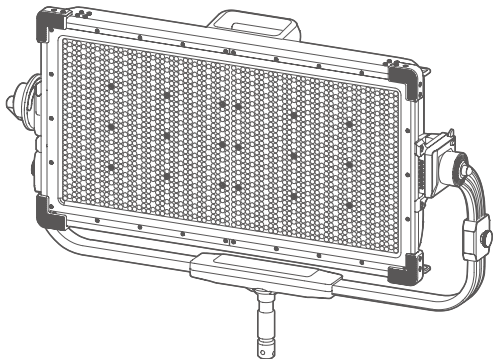

KNOWLED P1200R Hard P8

诺力 LED 影视面板灯
KNOWLED LED Light Panel

使用手册
Instruction Manual

V1.1 说明书 / Instruction Manual

V1.00 固件 / Firmware

重要的安全说明及注意事项

首先作为最基本原则：本产品为专业灯光布景设备，应由专业灯光师使用或在专业人士指导下使用。使用时必须始终遵循基本的安全预防措施，具体安全预防措施如下：

1. 使用前必须阅读并理解产品说明书。
2. 专业灯具，禁止儿童使用。当儿童靠近时，家长或监护人必须密切监督，以免儿童因碰撞灯具或私用灯具造成人身伤害。
3. 本灯具并非普通照明灯具，不可用于普通照明，任何有过眼部损伤或眼部敏感的人群均应避免使用本灯具。
4. 灯具点亮时，必须小心使用，禁止接触高温部件，如 LED 灯珠，以免造成灼伤。
5. 倘若灯珠损坏或因热变形，应停止使用，并及时联系制造商、服务代理商或合格的维修人员更换灯珠，以免发生意外。
6. 请勿使用损坏的设备或设备配件，待专业维修人员检查维修，确认设备正常方可使用。
7. 在使用过程中，如果本产品由于跌落、受到挤压或遭受强烈冲击而造成外壳破裂的，请勿继续使用，以免因接触到内部电子元件而受到电击伤害。
8. 部分产品电源线较长，请合理放置电源线，使其处于安全位置。避免电源线接触过热物体表面、避免放置不当导致拉扯损坏或绊倒现场人员。请使用本厂原装电源线，如使用非本厂电源线导致产品损坏，一概不在本厂维修范围内。
9. 此设备必须连接至具备可靠接地功能的电源插座使用，在拆装电源线时请先关闭电源，严禁通电时插拔。
10. 在清洁和维修之前，请务必从电源插座上拔下该设备插头。不使用时，禁止拉扯电源线以将设备插头从电源插座中拔出。正常断电，应是用手抓住该设备插头两端，将插头从电源插座中拔出。
11. 请勿私自拆卸产品，如产品出现故障，须由本公司或授权的维修人员进行检查维修。
12. 存放本设备之前，请确保设备已完全冷却。存放时，将电源线从设备上拔出。设备应放置于设备便携包内或通风干燥处。
13. 请勿将设备放置在酒精、汽油等易燃易挥发的溶剂附近。
14. 本厂不推荐的产品附件，请勿使用，以免导致火灾、触电或人身伤害。
15. 清洁本设备时，请勿用湿布擦拭，请用干布，软布擦拭设备污垢。
16. 一经发现，擅自检修设备，将取消一年保修期，维修需要收取相关费用。
17. 安全说明依据本厂严格测试制定，设备设计和规格如有变更，恕不另行通知。客户可以上神牛官网查看最新的电子版说明，了解产品最新资讯。



请勿直视光源

本设备包含型号核准代码为：CMIIT ID: 25J44811A029，
为该产品的无线电发射模块。

部件名称

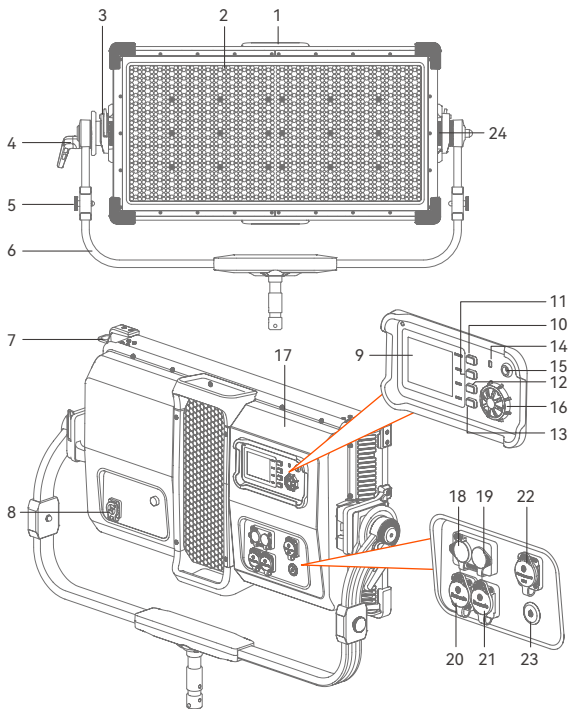

- | | | | |
|-----------|----------------|----------------|---------------|
| 1. 提手 | 7. 吊环 | 13. MODE 按键 | 19. DMX IN 接口 |
| 2. 灯珠 | 8. AC INPUT 接口 | 14. LED 状态灯 | 20. LAN 1 接口 |
| 3. 快装装置 | 9. 彩屏 | 15. CP 接口 | 21. LAN 2 接口 |
| 4. 方向锁紧把手 | 10. PRESET 按键 | 16. 调节旋钮 | 22. USB-A 接口 |
| 5. 挂线装置 | 11. LOCK 按键 | 17. NFC 感应区 | 23. 开关按键 |
| 6. U 架 | 12. MENU 按键 | 18. DMX OUT 接口 | 24. 附件快装卡槽 |

P1200R Hard P8 物品清单

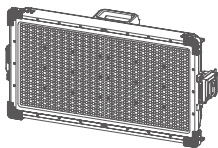

灯体 ×1

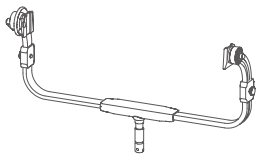

U 架 ×1



AC 电源线 ×1



安全绳 ×1



说明书 ×1

P1200R Hard P8 K1 物品清单

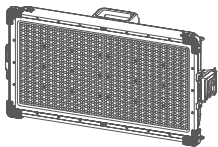

灯体 ×1

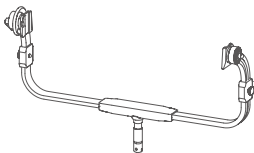

U架 ×1



AC 电源线 ×1



安全绳 ×1



收纳箱 ×1



说明书 ×1

温馨提示: 说明书中线图均为示意图, 仅供参考。由于产品不断更新与升级, 产品实物与线图可能存在差异, 请以实物为准。

安装 U 架

1. 按住灯体上的快装装置按钮，拨开扳手，将左右两侧都打开。
2. 双手握住 U 架两端，对准快装装置插入，接着将两边扳手回拨锁紧。
3. 最后可将整灯安装在另购的滚轮灯架上，锁紧滚轮灯架的固定旋钮即可。

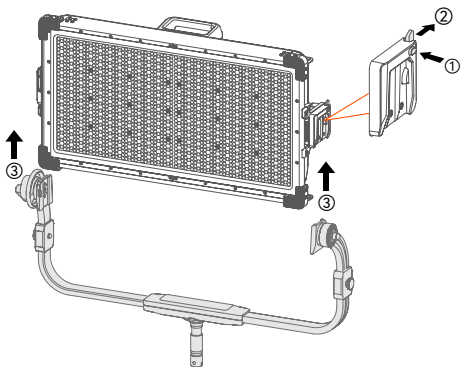

拆卸 U 架

1. 双手握住 U 架将灯具从滚轮灯架上取下来，放在平面上。
2. 按住快装装置按钮，拨开扳手，将 U 架取出。

⚠ 该灯具重量大，装卸过程需小心谨慎，以免造成人身伤害。

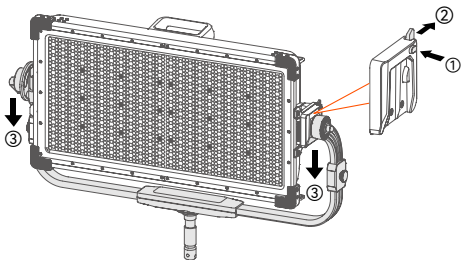

连接 DMX 控制台

1. 无线 DMX 连接

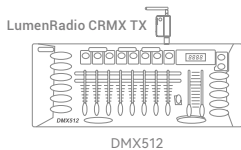

CRMX

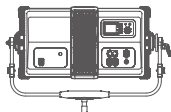

CRMX

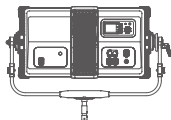

CRMX

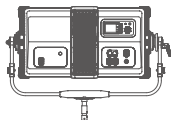

2. 有线 DMX 连接

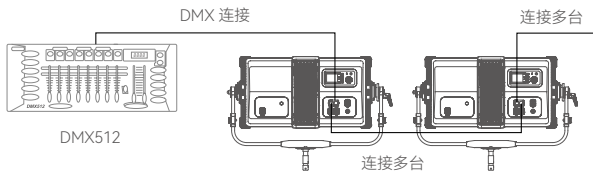

注：仅展示连接 DMX512 控制台方式，控制台及连接线需另购。

供电方式

- ①在插拔电源线时请先关闭电源，严禁通电时插拔。
- ②在拔出有锁扣按钮的电源线时，需要按住锁扣按钮同时旋转拔出。

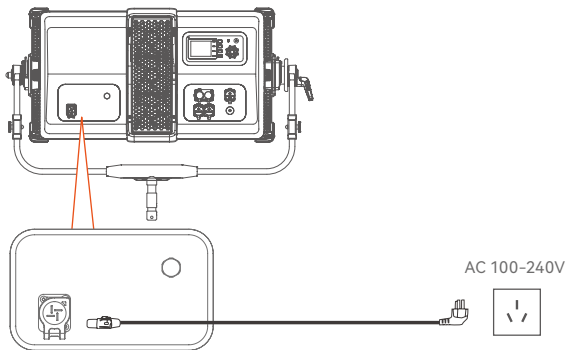

开关机

接通电源后按下开关按键实现开机，再次按下实现关机。

模式选择

短按 MODE 按键进入模式选择，旋转调节旋钮可选图中任意一种模式，短按调节旋钮进入该模式的具体设置。通过短按并旋转调节旋钮设置参数值，顺时针旋转递增参数值，逆时针旋转递减参数值，设置完毕短按 MODE 按键返回上一级。



CCT 模式

短按 MODE 按键进入模式选择，选中 CCT 后短按调节旋钮进入该模式。

亮度范围: 0.0% ~ 100.0%

色温范围: 1800K ~ 10000K

GM 范围: -100% ~ +100%

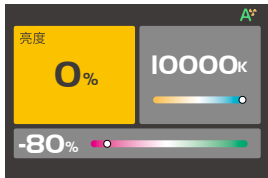

HSI 模式

短按 MODE 按键进入模式选择，选中 HSI 后短按调节旋钮进入该模式。

亮度范围: 0.0% ~ 100.0%

色相范围: 0° ~ 360°

饱和度范围: 0% ~ 100%



X-Y 模式

短按 MODE 按键进入模式选择, 选中 X-Y 后短按调节旋钮进入该模式。

亮度范围: 0.0% ~ 100.0%

X 坐标: 0.0000 ~ 0.8500

Y 坐标: 0.0000 ~ 0.8500

颜色温度或颜色空间: Gamut、Rec.2020、DCI-P3、Rec.709、Black body

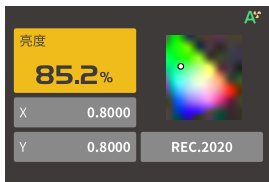

RGBW 模式

短按 MODE 按键进入模式选择, 选中 RGBW 后短按调节旋钮进入该模式。

亮度范围: 0.0% ~ 100.0%

红光范围: 0.0% ~ 100.0%

绿光范围: 0.0% ~ 100.0%

蓝光范围: 0.0% ~ 100.0%

白光范围: 0.0% ~ 100.0%

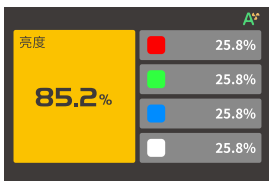

GEL 模式

短按 MODE 按键进入模式选择, 选中 GEL 后短按调节旋钮进入该模式。

亮度范围: 0.0% ~ 100.0%

色片类型: R-GEL/L-GEL

R-GEL 色片组: COR./CAL./SPC./CINE.

L-GEL 色片组: COR./COLOR./600/
COS./700

色温: 3200K 或 5600K

色相范围: -10° ~ 10°

饱和度范围: -20% ~ 20%



FX 模式

短按 MODE 按键进入模式选择，选中 FX 后短按调节旋钮进入该模式，通过旋转调节旋钮可选 17 类光效，短按调节旋钮进入某一类光效的具体设置。

光效	亮度	类型	色温 / 色相	速度	其他	
闪光灯	0.0% - 100.0%	CCT/HSI	1800K-10000K/0-360°	1-100	模式: 闪光灯 / 镁光灯 触发: 自动 / 手动	
雷闪电		×	1800K-10000K	×	闪烁次数: 随机 /1-10 频率: 随机 /2-20 触发: 自动 / 手动	
多云		×	×	随机 /1-100	亮暗比例: 10%-90%	
坏灯泡		CCT/HSI	1800K-10000K/0-360°	1-100	×	
电视机		CCT/HSI	×	1-100	×	
蜡烛		×	×	1-100	×	
火		×	×	1-100	×	
烟花		×	×	1-100	余烬: 1-100	
爆炸		CCT/HSI	1800K-10000K/0-360°	1-100	余烬: 1-100 触发: 自动 / 手动	
焊接		CCT/HSI	1800K-10000K/0-360°	1-100	×	
警车		红+蓝、红、蓝、蓝+白、 蓝+黄、黄、红+白 +蓝、红+黄+蓝	×	×	模式: 1-5	
SOS		CCT/HSI	1800K-10000K/0-360°	×	×	
彩光循环		×	×	1-100	饱和度: 0%-100%	
派对		×	×	1-100	饱和度: 0%-100%	
彩虹		像素数: 1、8 颜色长度: 1、2、3、4 颜色数量: 1、2、3、4、5、6、7、8 速度: 1-100 方向: 向左、向右 背景色设置 色温: 2700K、3200K、4300K、5600K、6500K、7500K 交叉量化: 0%-100% 色相: 0-360° 饱和度: 0%-100% 背景亮度: 0%-100%				
像素蜡烛		×	×	1-100	色调: 偏暖 / 中性 / 偏冷	
像素火		×	×	1-100	色调: 偏暖 / 中性 / 偏冷	

注: 根据需求旋转调节旋钮设置当前参数值, 设置完毕后短按并旋转调节旋钮可跳入下一栏参数进行设置; 每个光效均可设置开启或关闭; 选中手动时, 通过短按一次调节旋钮触发一次该光效; 某个光效设置完毕后短按 MODE 按键返回上一级。

菜单设置

短按 MENU 按键进入菜单界面，旋转并短按调节旋钮可进入图中任意一项的设置，设置完毕短按 MENU 按键返回上一级。

	DMX	001
	CRMX	开启
	蓝牙	开启
	以太网	DHCP
	Art-Net & sACN	Art-Net
	调光曲线	线性
	平滑度	平滑
	控制模式	常规
	色域空间	原始色域
	风扇	高速
	屏幕设置	80%
	语言	简体中文
	升级	V1.00
	恢复出厂设置	
	关于本机	

DMX

短按调节旋钮进入 DMX，通过短按并旋转调节旋钮设置参数值，如下表所示。

一级选项	二级选项	说明
地址	001-512	起始地址
DMX 模式	01: CCT 8 Bit	8 位 CCT 模式
	02: HSI 8 Bit	8 位 HSI 模式
	03: RGB 8 Bit	8 位 RGB 模式
	04: RGBW 8 Bit	8 位 RGBW 模式
	05: CCT+HSI 8 Bit	8 位 CCT+HSI 模式
	06: CCT+RGBW 8 Bit	8 位 CCT+RGBW 模式
	07: FX 8 Bit	8 位 FX 模式
	08: GEL 8 Bit	8 位 GEL 模式
	09: CCT 16 Bit	16 位 CCT 模式
	10: HSI 16 Bit	16 位 HSI 模式
	11: RGB 16 Bit	16 位 RGB 模式
	12: RGBW 16 Bit	16 位 RGBW 模式
	13: X-Y 16 Bit	16 位 X-Y 模式
	14: FX 16 Bit	16 位 FX 模式
	15: GEL 16 Bit	16 位 GEL 模式
	16: RGB 8Bit 2Pixels	8 位 RGB 2 像素模式
	17: RGBW 8Bit 2Pixels	8 位 RGBW 2 像素模式
	18: HSI 8Bit 2Pixels	8 位 HSI 2 像素模式
	19: CCT+RGBW 8Bit 2Pixels	8 位 CCT+RGBW 2 像素模式
	20: RGB 8Bit 8Pixels	8 位 RGB 8 像素模式
	21: RGBW 8Bit 8Pixels	8 位 RGBW 8 像素模式
	22: HSI 8Bit 8Pixels	8 位 HSI 8 像素模式
	23: CCT+RGBW 8Bit 8Pixels	8 位 CCT+RGBW 8 像素模式
	24: Ultimate 8 Bit	8 位 Ultimate DMX 模式
	25: Ultimate 16 Bit	16 位 Ultimate DMX 模式
RDM 状态	开启	开启 RDM，开启后控制台可设置灯具地址及 DMX 模式
	关闭	关闭 RDM
DMX 丢失状态	保持最后状态	失去 DMX 控制信号后，在关机或再次接收有效 DMX 控制信号前，持续使用最后一次接收的 DMX 控制信号。
	直接关闭	灯具直接熄灭
	保持最后状态 2 分钟熄灭	失去 DMX 控制信号后，持续使用最后一次接收的 DMX 控制信号 2 分钟，2 分钟后灯具熄灭。注：如 2 分钟内接收到有效 DMX 控制信号，则使用新的 DMX 控制信号。

终止开关	开启	开启 DMX 终端
	关闭	关闭 DMX 终端
增强通道	开启	开启增强通道信号
	关闭	关闭增强通道信号
DMX 通道表	(扫描二维码查看)	

注：使用 DMX/RDM 控制台控制灯具，可登录官网 <https://www.godox.com.cn/> 下载 DMX 模式表。

CRMX

短按调节旋钮进入 CRMX，通过短按并旋转调节旋钮设置开启或关闭；如需重置，旋转调节旋钮到重置栏，短按调节旋钮即可。



“Godox KNOWLED”app 下载

扫描二维码即可下载“Godox KNOWLED”app (目前仅限平板下载和使用)。



CRMX BT 转 CRMX

1. 首先通过 CRMX BT，将安卓/iOS 平板与 Godox TimoLink TRX 建立连接；
2. 再将 Godox TimoLink TRX 与 CRMX 灯具建立连接，或与 DMX 灯具（配合 Godox TimoLink RX 使用）建立连接；
3. 最后在“Godox KNOWLED”app 中配置灯具即可控制。

安卓/iOS 平板



“Godox KNOWLED” App



CRMX BT

Godox TimoLink TRX



CRMX

带 CRMX 的灯具



CRMX

不带 CRMX 的灯具

需使用 Godox TimoLink RX

注：TimoLink TRX/RX 为另购物品。

蓝牙

短按调节旋钮进入蓝牙，通过短按并旋转调节旋钮设置开启或关闭；如需蓝牙重置，旋转调节旋钮到重置栏，短按调节旋钮即可；下方查看蓝牙 MAC 码，方便查找灯具。



“Godox Light”app 下载

扫描二维码即可下载“Godox Light”手机 app（安卓和苹果系统都可以使用）。

注：

1. 首个移动设备（手机或平板电脑）可直接使用 app 操控灯体。更换其他移动设备时，灯体需进行蓝牙重置方可正常使用 app。
2. app 需升级至 V3.0 以上版本。



以太网

短按调节旋钮进入以太网设置，通过短按并旋转调节旋钮设置网络模式，如下表所示。



一级选项	二级选项	说明
网络模式	DHCP	使用 DHCP 模式
	Art-Net2.x	使用 2.B.C.D 网络
	Art-Net 10.x	使用 10.B.C.D 网络
	手动	可手动设置网络 IP、子网掩码、默认网关
IP	AAA.BBB.CCC. DDD	如果启动 DHCP 模式，灯光 ID 地址则为 DHCP 分配。 如果启动 Art-Net 2.x 模式，灯光 ID 地址则为 2.B.C.D。 如果启动 Art-Net 10.x 模式，灯光 ID 地址则为 10.B.C.D。 如果启动手动模式，AAA = 0-255 BBB = 0-255 CCC = 0-255 DDD = 0-255
子网掩码	255.BBB.CCC. DDD	如果启动 DHCP/Art-Net 2.x/Art-Net 10.x，子网掩码为 255.BBB.CCC.DDD 不能通过菜单更改。 如果启动手动，AAA = 0-255 BBB = 0-255 CCC = 0-255 DDD = 0-255
默认网关	AAA.BBB.CCC. DDD	如果启动 DHCP 模式，灯光默认网关则为 DHCP 分配。 如果启动 Art-Net 2.x 模式，灯光默认网关址则为 2.B.C.D。 如果启动 Art-Net 10.x 模式，灯光默认网关则为 10.B.C.D。 如果启动手动模式，AAA = 0-255 BBB = 0-255 CCC = 0-255 DDD = 0-255

Art-Net & sACN

短按调节旋钮进入 Art-Net & sACN，通过短按并旋转调节旋钮设置参数值，如下表所示。

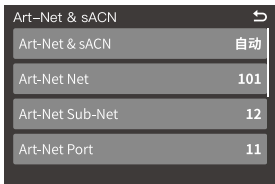

一级选项	二级选项	说明
Art-Net&sACN	自动 /Art-Net/sACN/ 关	自动: 接受 Art-Net&sACN 两种协议。 Art-Net: 只接受 Art-Net 协议。 sACN: 只接受 sACN 协议。 关: 不接受网络协议。
Art-Net Net	0-127	选择 Art-Net 网络
Art-Net Sub-Net	0-15	在 Art-Net 网络中选择 Art-Net 子网
Art-Net Port	0-15	Art-Net 端口
Art-Net Universe	0-32767	Art-Net 域
sACN Universe	1-63999	sACN 域

调光曲线

短按调节旋钮进入调光曲线，通过旋转调节旋钮可选线性 /S 曲线 / 指数 / 对数，选定后短按调节旋钮完成设置。



平滑度

短按调节旋钮进入平滑度，通过旋转调节旋钮可选默认 / 平滑 / 平滑关，选定后短按调节旋钮完成设置。

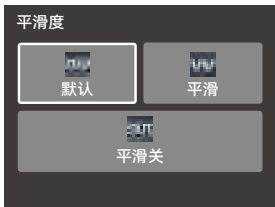

平滑度	备注
默认	亮度数据进行基础平滑处理，实现平滑调光，缩短响应时间
平滑度	亮度数据进行平滑处理，实现超平滑调光，响应时间慢
关闭	未对亮度数据进行平滑处理，响应时间最快

控制模式

短按调节旋钮进入控制模式，通过短按并旋转调节旋钮可选常规 / 低亮 / 高速三种模式，选定后短按并旋转调节旋钮可设置常规和低亮模式的频率，范围：默认 / 1-10



控制模式	适用环境	调光特性	闪烁
常规模式	正常调光	整个调光范围内都很好	不太会出现闪烁
低亮模式	电视 / 电影	低亮度水平时很好	可能出现闪烁
高速模式	不支持调光	/	无闪烁

色域空间

短按调节旋钮进入色域空间，通过短按并旋转调节旋钮可选原始色域 / 校色色域 / Rec.709 / DCI-P3。

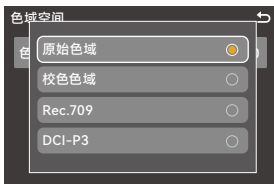

风扇

短按调节旋钮进入风扇，通过旋转调节旋钮可选静音 / 自动 / 中速 / 高速，选定后短按调节旋钮完成设置。



屏幕设置

短按调节旋钮进入屏幕设置，通过短按并旋转调节旋钮设置 10%-100% 屏幕亮度，设置完毕短按并旋转调节旋钮到下一栏设置屏幕方向：默认 / 倒置 / 自动。



语言

短按调节旋钮进入语言，通过旋转调节旋钮可选简体中文/English，选定后短按调节旋钮完成设置。



升级

短按调节旋钮进入升级，此界面可查看固件版本号与升级提示。

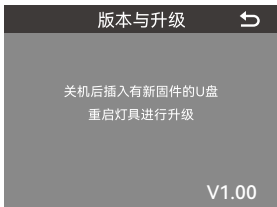

升级详情

1. 在官网 (<https://www.godox.com.cn/firmware-continuous-light>) 下载新固件到 U 盘上。
2. 在关机状态下，将存有新固件的 U 盘插入 USB-A 接口。
3. 开机，灯具自动进入升级界面。
4. 升级完毕自动跳回主界面。

- 注：1. 必须在官网下载新固件，存放在 U 盘根目录里，而且仅有一个 BIN 文件。
2. USB-A 接口支持供电，输出电压电流 5V= 1.5A，请勿接入大功率 USB 设备。

恢复出厂设置

短按调节旋钮进入恢复出厂设置，通过旋转调节旋钮可选确定 / 取消；短按调节旋钮确定恢复出厂，灯具自动重启，界面出现简体中文和 English 选项，设置需要的语言后灯体亮度值自动变为 100%。



关于本机

短按调节旋钮进入关于本机，此界面可查看当前灯具的基础信息。

NFC 加灯

1. 开启手机与灯具的蓝牙功能，确保“Godox Light”app 版本在 V3.2.4 以上。
2. 打开 app 进入对应场景，点击 + 选择“NFC 加灯”，手机靠近灯具 NFC 感应区即可完成加灯。

锁定设置

短按 LOCK 按键，屏幕出现 () 表示当前界面被锁定；再次短按 LOCK 按键便可解锁。

注：此锁定功能仅锁定本设备的操控面板，其他操作方式仍可正常进行。



预设设置

短按 PRESET 按键进入灯具光效的预设界面，旋转调节旋钮选择 1-20 组预设。

1. 短按 MODE 按键进入主界面，设置好光效参数；
2. 短按 PRESET 按键进入预设界面，要将此光效参数存入预设 1，选定预设 1 后短按调节旋钮进行保存；
3. 已保存的预设组，短按调节旋钮可进行应用 / 保存 / 取消设置。

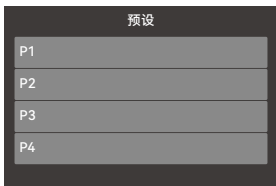

照度数据

常规模式

色温	测试条件	照度单位	1m	3m	5m	10m
1800K	裸灯	lux	81200	9980	3820	928
		fc	7550	927	355	86.2
2800K		lux	128000	16000	5980	1550
		fc	11800	1490	555	144
3200K		lux	129000	16300	6020	1580
		fc	11900	1510	559	146
4300K		lux	133000	16900	6240	1640
		fc	12400	1570	579	152
5600K		lux	141000	17600	6550	1720
		fc	13100	1630	609	160
6500K		lux	145000	18300	6810	1790
		fc	13500	1700	633	166
8500K	lux	144000	18200	6700	1760	
	fc	13400	1690	623	163	
10000K	lux	138000	17200	6380	1680	
	fc	12800	1600	593	156	
R (红光)	lux	38700	4930	1730	480	
	fc	3600	458	161	45	
G (绿光)	lux	52200	6530	2390	647	
	fc	4850	607	222	60	
B (蓝光)	lux	12900	1590	582	157	
	fc	1200	147	54	15	

高速模式

色温	测试条件	照度单位	1m	3m	5m	10m
1800K	裸灯	lux	92600	11900	4350	1120
		fc	8610	1110	404	104
2800K		lux	142000	18000	6700	1760
		fc	13200	1670	622	164
3200K		lux	146000	18500	6900	1820
		fc	13600	1710	641	170
4300K		lux	156000	19500	7290	1930
		fc	14500	1820	677	179
5600K		lux	161000	20000	7510	1990
		fc	15000	1860	698	185
6500K		lux	162000	20200	7500	2000
		fc	15000	1880	696	186
8500K		lux	163000	20400	7560	2020
		fc	15100	1900	702	187
10000K	lux	157000	19800	7270	1950	
	fc	14600	1840	676	181	
R(红光)	lux	38700	4930	1730	480	
	fc	3600	458	161	45	
G(绿光)	lux	52200	6530	2390	647	
	fc	4850	607	222	60	
B(蓝光)	lux	12900	1590	582	157	
	fc	1200	147	54	15	

以上数据均为平均值，非绝对值，以上测试皆在灯体 100%亮度下进行。

规格参数

型号	P1200R Hard P8
AC INPUT 接口	100V-240V~ 50/60Hz, 1400W
色温范围	1800K ~ 10000K
GM 范围	-100% ~ 100%
调光范围	0.0% ~ 100.0%
调光曲线	线性 / S 曲线 / 指数 / 对数
FX 光效	17 类
CRI	≈ 97
TLCI	≈ 98
防水等级	IP65
控制方式	DMX/RDM, CRMX, 以太网, 蓝牙, 灯体控制
蓝牙控制距离	30m
USB-A 接口	固件升级 / 5V $\overline{\text{---}}$ 1.5A 供电
工作环境温度	-20°C ~ 45°C
尺寸 (不含 U 架)	≈ 737mm*151mm*385mm
净重 (不含 U 架)	≈ 17.6kg

规格和参数如有变更, 恕不另行通知。

Important Safety Instructions and Precautions

First of all, as the most basic principle: This product is a professional lighting set equipment and should be used by professional lighting engineers or under the guidance of professionals. Basic safety attentions must always be followed during use, as follows:

1. Before use, please read and understand the instruction manual.
2. Professional lighting is prohibited for children. When children are near, parents or accompanying persons must supervise closely to prevent children from personal injury due to collision with lamps or private use of lamps.
3. This lighting product is not ordinary lighting product and cannot be used for general lighting. Anyone who has suffered eye damage or has sensitive eyes should avoid using this product.
4. When the lamp is on, it must be used with care. Do not touch high-temperature parts, such as LED lamp beads, to avoid burns.
5. If the lamp bead is damaged or deformed by heat, stop using this equipment, and contact the manufacturer, service agent or qualified maintenance personnel to replace the lamp bead in time to avoid accidents.
6. Do not use damaged equipment or accessories, and wait for professional maintenance personnel to check and repair to confirm being normal before use.
7. During using, if the casing of this product is broken due to being dropped, squeezed or subjected to strong impact, please do not use it, so as to avoid electric shock injury due to contact with internal electronic components.
8. Some products have long power cords, please place the power cords properly and keep them in a safe place. Avoid contacting the power cord with overheating surfaces, avoid improper placement that could cause pulling damage, or trip on-site personnel. Please use the certified power cord from the original manufacturer. If the product is damaged by using a non-certified power cord, it will not be repaired by our factory.
9. This device must be connected to a power outlet with a reliable grounding function. Please power off before connecting or disconnecting the power cord, and never plug or unplug it while the power is on.
10. Be sure to unplug equipment from the power outlet before cleaning and repairing. When not in use, do not pull the power cord to unplug the equipment. For normal power-off, please hold both ends of the plug of the equipment with your hands and pull the plug out of power outlet.

11. Do not disassemble the product without permission. If the product fails, it must be checked and repaired by authorized maintenance personnel.
12. Before storing, make sure that the equipment has cooled down completely. For storage, unplug the power cord from the equipment. The equipment should be placed in the carrying case or in a ventilated dry place.
13. Do not place equipment near flammable and volatile solvents such as alcohol and gasoline.
14. Do not use accessories that are not recommended by our factory to avoid fire, electric shock or personal injury.
15. When cleaning the device, please do not use a wet cloth to wipe, please use a dry, soft cloth to wipe the dirt on the device.
16. If it is found that the equipment is repaired without authorization, the one-year warranty period will be cancelled and relevant fees will be charged for maintenance.
17. The safety instructions are formulated according to the strict testing of the factory, and the design and specifications of the equipment are subject to change without prior notice. For latest product information, please check the GODOX website and view latest electronic instruction.



Do not stare at the operating light source.

Names of Parts

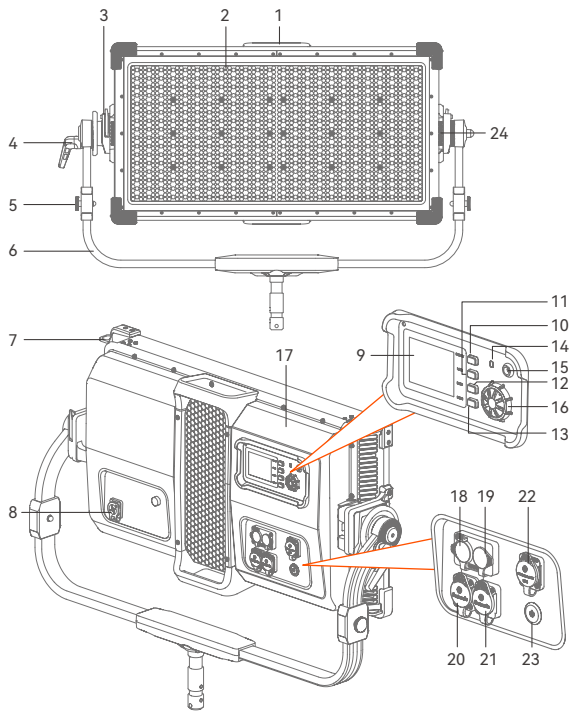

- | | | | |
|-----------------------------|-------------------|----------------------|-----------------------------------|
| 1. Handle | 7. Hanging Ring | 13. MODE Button | 19. DMX IN Port |
| 2. Lamp Bead | 8. AC INPUT Port | 14. LED Indicator | 20. LAN 1 Port |
| 3. Quick Install Device | 9. Color Screen | 15. CP Port | 21. LAN 2 Port |
| 4. Direction Locking Handle | 10. PRESET Button | 16. Select Dial | 22. USB-A Port |
| 5. Hanging Device | 11. LOCK Button | 17. NFC Sensing Area | 23. Power Switch Button |
| 6. U-bracket | 12. MENU Button | 18. DMX OUT Port | 24. Accessory Quick Mounting Slot |

What's Inside P1200R Hard P8

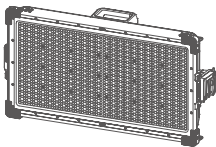

Light Body × 1

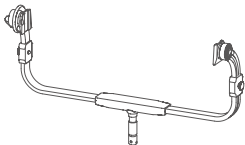

U-bracket × 1



AC Power Cord × 1



Safety Rope × 1



Instruction Manual × 1

What's Inside P1200R Hard P8 K1

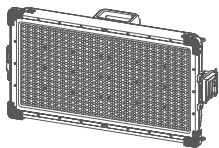

Light Body × 1

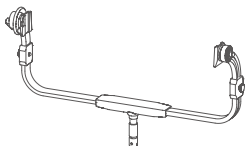

U-bracket × 1



AC Power Cord × 1



Safety Rope × 1

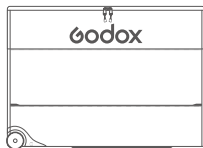

Storage Case × 1



Instruction Manual × 1

Note: Due to continuous updates and upgrades of the products, there may be differences between the actual products and the pictures. Therefore, the pictures are for reference only, products to prevail in kind.

Installing the U-bracket

1. Press and hold the quick install device button on the light body, push aside the wrench to open both the left and right sides.
2. Hold both ends of the U-bracket, align the quick install device and insert it, then turn back the wrenches on both sides to lock it properly.
3. Install the light on the roller stand and lock the fixing knob on the roller stand.

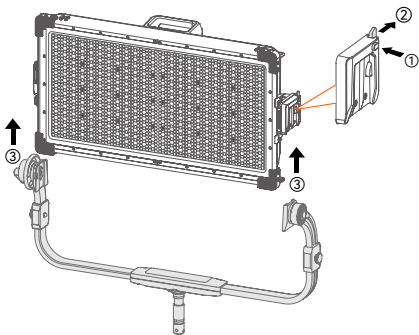

Disassembling the U-bracket

1. Hold the U-bracket to remove the fixture from the roller stand and place it on a flat surface.
2. Press and hold the quick-install device button, push aside the wrench to remove the U-bracket.

⚠ Please be careful when installing the light as it is quite heavy and may cause personal injuries.

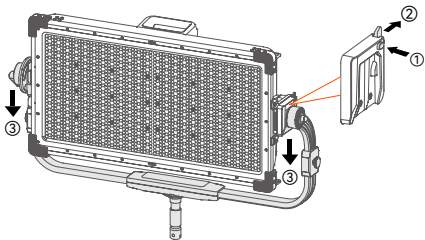

Connecting to DMX Controller

1. Wireless DMX Connection

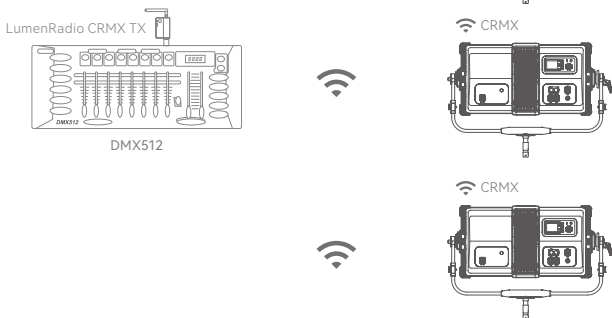

2. Wired DMX Connection

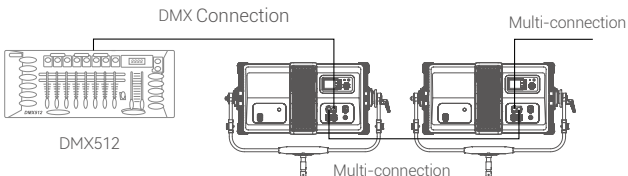

Note: The above pictures only show the method to connect the DMX512 controller, the controller and connecting cable are sold separately.

Power Supply

- ① Please turn off the power when disassembling and installing the power cord, it is strictly forbidden to plug and unplug when the power is on.
- ② Please press the latch button and rotate anticlockwise when disassembling the power cord with latch button.

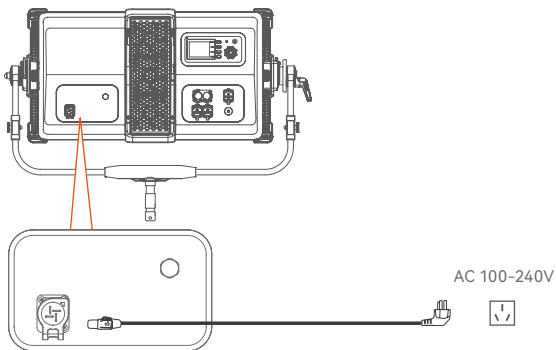

Power Switch

Press the power switch button after connecting to power source to turn the device on or off.

Mode Selection

Press the MODE button to enter selection interface, rotate the select dial to select the desired mode, then press it to enter the corresponding parameter settings. Rotate the select dial clockwise to increase the parameters, while rotate anticlockwise to decrease the parameters. Press the MODE button to return to the previous interface.



CCT Mode

Press the MODE button to enter mode selection, rotate and press the select dial to select CCT mode, in which you can adjust the DIM/CCT/GM.

DIM range: 0.0% ~ 100.0%

CCT range: 1800K ~ 10000K

GM range: -100% ~ +100%

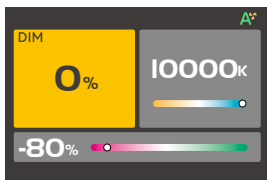

HSI Mode

Press the MODE button to enter mode selection, rotate and press the select dial to select HSI mode, in which you can adjust the DIM/HUE/SAT.

DIM range: 0.0% ~ 100.0%

HUE range: 0° ~ 360°

SAT range: 0% ~ 100%

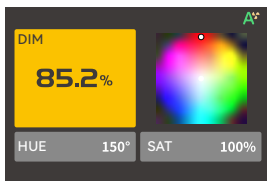

X-Y Mode

Press the MODE button to enter mode selection, rotate and press the select dial to select X-Y mode, in which you can adjust the DIM/X coordinate/Y coordinate/color temperature/color space.

DIM range: 0.0% ~ 100.0%

X coordinate: 0.0000 ~ 0.8500

Y coordinate: 0.0000 ~ 0.8500

Color temperature or color space: Gamut, Rec.2020, DCI-P3, Rec.709, Black Body

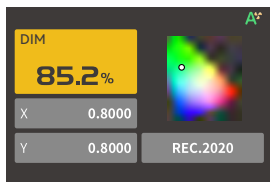

RGBW Mode

Press the MODE button to enter mode selection, rotate and press the select dial to select RGBW mode, in which you can adjust the DIM/red/green/blue/white.

DIM range: 0.0% ~ 100%

Red range: 0.0% ~ 100%

Green range: 0.0% ~ 100%

Blue range: 0.0% ~ 100%

White range: 0.0% ~ 100%

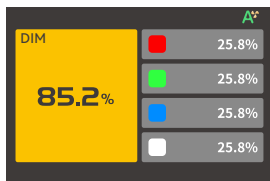

GEL Mode

Press the MODE button to enter mode selection, rotate and press the select dial to select GEL mode, in which you can adjust the DIM/gel type/gel group type/CCT/HUE/SAT.

DIM range: 0.0% ~ 100%

Gel type: R-GEL/L-GEL

R-GEL gel group: COR./CAL./SPC./CINE.

L-GEL gel group: COR./COLOR./600/

COS./700

CCT range: 3200K or 5600K

HUE range: -10° ~ 10°

SAT range: -20% ~ 20%

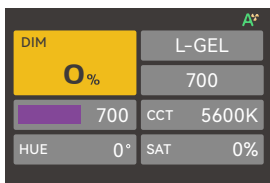

FX Mode

Press the MODE button to enter mode selection, rotate and press the select dial to select FX mode, in which you can choose among the 17 effects and adjust their respective parameters.

Effect	DIM	Type	CCT/HUE	Speed	Others	
Flash	0.0% - 100.0%	CCT/HSI	1800K-10000K/0-360°	1-100	Mode: Camera Flash/Flash Bulb Trigger: Auto/Manual	
Lightning		x	1800K-10000K	x	Times: Random/1-10 Frequency: Random /2-20 Trigger: Auto/Manual	
Cloudy		x	x	Random/1-100	Ratio: 10% -90%	
Broken Bulb		CCT/HSI	1800K-10000K/0-360°	1-100	x	
TV		CCT/HSI	x	1-100	x	
Candle		x	x	1-100	x	
Fire		x	x	1-100	x	
Firework		x	x	1-100	Embers: 1-100	
Explosion		CCT/HSI	1800K-10000K/0-360°	1-100	Embers: 1-100 Trigger: Auto/Manual	
Welding		CCT/HSI	1800K-10000K/0-360°	1-100	x	
Police Car		Red+Blue, Red, Blue, Blue+White, Blue+Yellow, Yellow, Red+White+Blue, Red+Yellow+Blue	x	x	Mode: 1-5	
SOS		CCT/HSI	1800K-10000K/0-360°	x	x	
RGB Cycle		x	x	1-100	SAT: 0%-100%	
Party		x	x	1-100	SAT: 0%-100%	
Rainbow		Pixel NO.: 1, 8 Color Length: 1, 2, 3, 4 Color NO.: 1, 2, 3, 4, 5, 6, 7, 8 Speed: 1-100 Direction: Left, Right Background Color CCT: 2700K, 3200K, 4300K, 5600K, 6500K, 7500K Crossfade: 0%-100% HUE: 0-360° SAT: 0%-100% Background Dimming: 0%-100%				
Px Candle		x	x	1-100	Tone: Warm/Neutral/Cool	
Px Fire		x	x	1-100	Tone: Warm/Neutral/Cool	

Note: Please rotate the select dial to adjust the parameters, then press the and rotate the select dial to the next parameter. Every effect can be turned on or off individually. Select manual, the effect can be triggered once by pressing the select dial once. After a certain effect is set, press MODE button can return to the 17 effects interface.

MENU Settings

Press the MENU button to enter menu interface, rotate and press the select dial to enter the following setting options, press the MENU button can return to the previous interface.

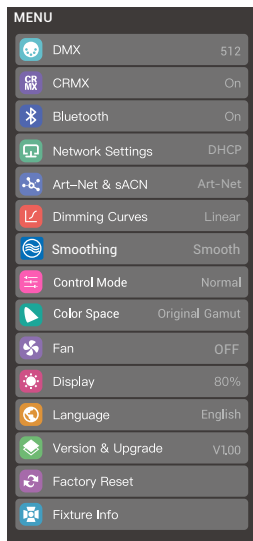

DMX

Press the select dial to enter DMX interface, press and rotate the select dial to adjust the following settings.

Level 1 Option	Level 2 Option	Description
Address	001-512	Initial address
DMX Mode	01: CCT 8 Bit	CCT mode in 8bit
	02: HSI 8 Bit	HSI mode in 8bit
	03: RGB 8 Bit	RGB mode in 8bit
	04: RGBW 8 Bit	RGBW mode in 8bit
	05: CCT+HSI 8 Bit	CCT+HSI mode in 8bit
	06: CCT+RGBW 8 Bit	CCT+RGBW mode in 8bit
	07: FX 8 Bit	FX mode in 8bit
	08: GEL 8 Bit	GEL mode in 8bit
	09: CCT 16 Bit	CCT mode in 16bit
	10: HSI 16 Bit	HSI mode in 16bit
	11: RGB 16 Bit	RGB mode in 16bit
	12: RGBW 16 Bit	RGBW mode in 16bit
	13: X-Y 16 Bit	X-Y mode in 16bit
	14: FX 16 Bit	FX mode in 16bit
	15: GEL 16 Bit	GEL mode in 16bit
	16: RGB 8Bit 2Pixels	RGB 2Pixels mode in 8Bit
	17: RGBW 8Bit 2Pixels	RGBW 2Pixels mode in 8Bit
	18: HSI 8Bit 2Pixels	HSI 2Pixels mode in 8Bit
	19: CCT+RGBW 8Bit 2Pixels	CCT+RGBW 2Pixels mode in 8Bit
	20: RGB 8Bit 8Pixels	RGB 8Pixels mode in 8Bit
	21: RGBW 8Bit 8Pixels	RGBW 8Pixels mode in 8Bit
	22: HSI 8Bit 8Pixels	HSI 8Pixels mode in 8Bit
	23: CCT+RGBW 8Bit 8Pixels	CCT+RGBW 8Pixels mode in 8Bit
	24: Ultimate 8 Bit	Ultimate DMX mode in 8bit
	25: Ultimate 16 Bit	Ultimate DMX mode in 16bit
RDM State	On	Turn on RDM, the controller can set the fixture address and DMX mode
	Off	Turn off RDM
DMX Lost	Hold Last Command	After the DMX control signal is lost, continue to use the last received DMX control signal until power down or a valid DMX control signal is received again.
	Black Out	The light is off immediately.
	Black Out After 2 min	After the DMX control signal is lost, continue to use the last received DMX control signal for 2 minutes then black out. Note: If a valid DMX control signal is received within 2 minutes, then use the new DMX control signal.

Termination	On	Turn on DMX terminal
	Off	Turn off DMX terminal
Extend DMX Channels	On	Turn on extend DMX channels
	Off	Turn off extend DMX channels
DMX Table	Scan the QR code to check DMX table	

Note: Please refer to the DMX Mode Specification to control the device by DMX/RDM. The electronic version can be downloaded from the official website <https://www.godox.com>.

CRMX

Press the select dial to enter CRMX interface, press and rotate the select dial to turn on/off, or reset.

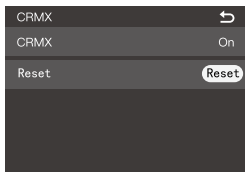

"Godox KNOWLED" app Downloading

Scan the QR code to download "Godox KNOWLED" app (Currently available for tablet download and use only).



CRMX BT to CRMX

1. First, connect the Android/iOS tablet to Godox TimoLink TRX via the CRMX BT.
2. Then connect Godox TimoLink TRX to CRMX fixtures, or DMX fixtures (used with Godox TimoLink RX).
3. Finally, add the fixtures in "Godox KNOWLED" app to control them.

Android/iOS tablet



"Godox KNOWLED" App



CRMX BT

Godox TimoLink TRX



CRMX

Fixture with CRMX



CRMX

Fixture without CRMX need to be used with **Godox TimoLink RX**

Note: TimoLink TRX and TimoLink RX are sold separately.

Bluetooth

Press the select dial to enter Bluetooth interface, press and rotate the select dial to Bluetooth to turn it on or off. If you need to reset the Bluetooth, rotate the select dial to reset and press it. The MAC code is on the corner for quick check.

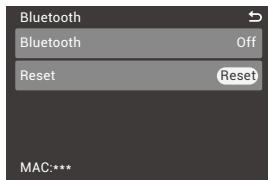

"GODOX Light" app Downloading

Scan the QR code to download the "Godox Light" smartphone app (can be used in Android and iOS).

Note:

1. The app can be used directly on the firstly installed device (smartphone or tablet). When change to other mobile device (smartphone or tablet), the light shall be reset before the normal connection of the app.
2. The app should be version 3.0 or above.



Network Settings

Press the select dial to enter network settings interface, press and rotate the select dial to adjust the parameters as follows.

Network Settings	↩
Network Mode	Manual
IP	192 168 1 100
Subnet Mask	255 255 255 0
Gateway	192 168 1 1
MAC:***	

Level 1 Option	Level 2 Option	Description
Network Mode	DHCP	DHCP mode
	Art-Net2.x	To use 2.B.C.D network
	Art-Net 10.x	To use 10.B.C.D network
	Manual	Set the network IP, subnet mask, and default gateway manually
IP	AAA.BBB.CCC.DDD	The ID address is assigned by DHCP in DHCP mode. The ID address is 2.B.C.D in Art-Net 2.x mode. The ID address is 10.B.C.D in Art-Net 10.x mode. In manual mode: AAA = 0-255 BBB = 0-255 CCC = 0-255 DDD = 0-255
Subnet Mask	255.BBB.CCC.DDD	The subnet mask is 255.BBB.CCC.DDD and can not be adjusted by menu settings in DHCP/Art-Net 2.x/Art-Net 10.x mode. In manual mode: AAA = 0-255 BBB = 0-255 CCC = 0-255 DDD = 0-255
Gateway	AAA.BBB.CCC.DDD	The gateway is assigned by DHCP in DHCP mode. The gateway is 2.B.C.D in Art-Net 2.x mode. The gateway is 10.B.C.D in Art-Net 10.x mode. In manual mode: AAA = 0-255 BBB = 0-255 CCC = 0-255 DDD = 0-255

Art-Net & sACN

Press the select dial to enter Art-Net & sACN interface, press and rotate the select dial to adjust the parameters as follows.

Art-Net & sACN	
Art-Net & sACN	Auto
Art-Net Net	101
Art-Net Sub-Net	12
Art-Net Port	11
Art-Net Universe	0
sACN Universe	1

Level 1 Option	Level 2 Option	Description
Art-Net&sACN	Auto/Art-Net/sACN/Off	Auto: Art-Net & sACN two protocols are accepted. Art-Net: Only Art-Net protocol. sACN: Only sACN protocol. Off: No network protocols are accepted.
Art-Net Net	0-127	Art-Net network
Art-Net Sub-Net	0-15	Choose Art-Net subnet in Art-Net network
Art-Net Port	0-15	Art-Net port
Art-Net Universe	0-32767	Art-Net universe
sACN Universe	1-63999	sACN universe

Dimming Curves

Press the select dial to enter dimming curves interface, press and rotate the select dial to choose among linear, S-curve, exponential and logarithmic.

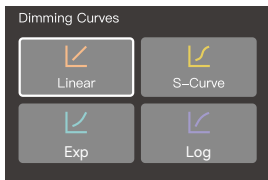

Smoothing

Press the select dial to enter smoothing setting interface, press and rotate the select dial to choose among default, smooth and off.



Smoothing	Note
Default	The brightness data is basically smoothed to achieve smooth dimming and shorten the response time.
Smooth	The brightness data is smoothed to achieve ultra-smooth dimming with a slow response time.
Off	No smoothing of brightness data, fastest response time.

Control Mode

Press the select dial to enter control mode interface, press and rotate the select dial to choose the mode among normal, low end and highspeed, then press and rotate the select dial adjust the frequency of normal and low end modes to default or from 1 to 10.

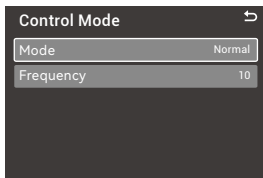

Control Mode	Suitable Environment	Dimming Feature	Blink
Normal	Normal dimming	Proper in the whole dimming range	Unlikely
Low End	TV series/Movie	Proper in low dimming	Probably
Highspeed	Not dimmable	/	No

Color Space

Short press the select dial to enter color space interface, press and rotate the select dial to choose among original gamut, correction gamut, Rec.709 and DCI-P3.

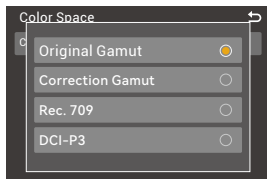

Fan

Press the select dial to enter fan interface, press and rotate the select dial to choose among off, auto, medium and high.

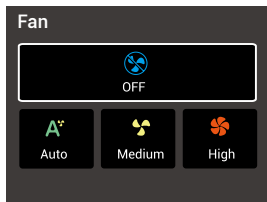

Display

Short press the select dial to enter display interface, press and rotate the select dial to adjust the display brightness from 10% to 100%, and adjust the display orientation among default, invert and auto.

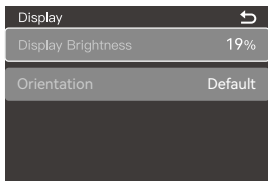

Language

Press the select dial to enter language interface, press and rotate the select dial to choose between simplified Chinese and English.

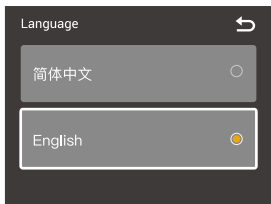

Version & Upgrade

Press the select dial to enter version & upgrade interface to check the firmware version and upgrade instruction.



Firmware Upgrade

1. Download the new firmware to the U disk from official website (<https://www.godox.com/firmware-continuous-light>).
2. Turn off the device. Insert the U disk with new firmware into the USB-A port.
3. Turn on the device, and it will automatically enter the upgrading interface.
4. It will return to main interface after completion.

Notes:

1. New firmware must be downloaded from the official website, and keep only one BIN file in the root directory of the USB disk.
2. The USB-A port can only support output voltage and current of 5V= 1.5A. Do not connect to over-rated USB device.

Factory Reset

Press the select dial to enter factory reset interface to choose yes or no. If you choose yes, the device will automatically reset and reboot, then simplified Chinese and English options show on the display for your choice, after which the brightness will turn to 100% automatically.

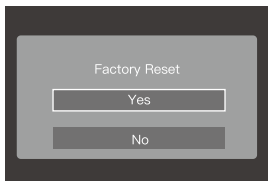

Fixture Info

Press the select dial to enter fixture info interface to check the basic information of the product.

NFC Fixture Addition

1. Make sure the Bluetooth and NFC functions of smartphone and fixture are turned on, the **【Godox Light】** app is V3.2.4 or above.
2. Turn on the **【Godox Light】** app and enter the corresponding scene, click **【+】** to select **【NFC Addition】** function, bring the NFC sensing area of smartphone near the sensing area of fixture to scan to add.

Lock Setting

Press the LOCK button, the panel is locked when is displayed on the panel, press it again to unlock.

Note: The locking function only works on the controller panel, other operations are still available.

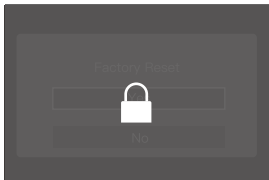

Preset Setting

Press the PRESET button to enter preset effects interface. Rotate and press the select dial to choose and enter preset effects 1-20.

1. Press the MODE button to enter the mode interface and set the desired parameters.
2. Press the PRESET button to enter the preset interface, if you want to save this effect as preset 1, choose preset 1 and press the select dial to save.
3. You can apply, save or cancel the preset groups by rotating and pressing the select dial.



Illuminance Data

Normal Mode

CCT	Testing Condition	Unit	1m	3m	5m	10m
1800K	Bare Light	lux	81200	9980	3820	928
		fc	7550	927	355	86.2
2800K		lux	128000	16000	5980	1550
		fc	11800	1490	555	144
3200K		lux	129000	16300	6020	1580
		fc	11900	1510	559	146
4300K		lux	133000	16900	6240	1640
		fc	12400	1570	579	152
5600K		lux	141000	17600	6550	1720
		fc	13100	1630	609	160
6500K		lux	145000	18300	6810	1790
		fc	13500	1700	633	166
8500K	lux	144000	18200	6700	1760	
	fc	13400	1690	623	163	
10000K	lux	138000	17200	6380	1680	
	fc	12800	1600	593	156	
R (Red)	lux	38700	4930	1730	480	
	fc	3600	458	161	45	
G (Green)	lux	52200	6530	2390	647	
	fc	4850	607	222	60	
B (Blue)	lux	12900	1590	582	157	
	fc	1200	147	54	15	

High-speed Mode

CCT	Testing Condition	Unit	1m	3m	5m	10m
1800K	Bare Light	lux	92600	11900	4350	1120
		fc	8610	1110	404	104
2800K		lux	142000	18000	6700	1760
		fc	13200	1670	622	164
3200K		lux	146000	18500	6900	1820
		fc	13600	1710	641	170
4300K		lux	156000	19500	7290	1930
		fc	14500	1820	677	179
5600K		lux	161000	20000	7510	1990
		fc	15000	1860	698	185
6500K		lux	162000	20200	7500	2000
		fc	15000	1880	696	186
8500K		lux	163000	20400	7560	2020
		fc	15100	1900	702	187
10000K	lux	157000	19800	7270	1950	
	fc	14600	1840	676	181	
R (Red)	lux	38700	4930	1730	480	
	fc	3600	458	161	45	
G (Green)	lux	52200	6530	2390	647	
	fc	4850	607	222	60	
B (Blue)	lux	12900	1590	582	157	
	fc	1200	147	54	15	

Note: All the data are average values instead of absolute values. All the above tests are based on the condition of 100% brightness.

Technical Data

Model	P1200R Hard P8
AC INPUT Port	100V-240V ~ 50/60Hz, 1400W
CCT Range	1800K ~ 10000K
GM Adjust	-100% ~ 100%
Brightness Range	0.0% ~ 100.0%
Dimming Curves	linear, S-curve, exponential, logarithmic
FX Modes	17
CRI	≈97
TLCI	≈98
Protection Grade	IP65
Controlling Methods	DMX/RDM, CRMX, Ethernet, Bluetooth, light body control
Bluetooth Controlling Distance	30m
USB-A Port	Firmware Upgrade/5V= 1.5A Power Supply
Working Environment Temperature	-20°C~ 45°C
Dimension (excluding U-bracket)	≈29.02*5.94*15.16"
Net Weight (excluding U-bracket)	≈17.6kg

Specifications and data may subject to changes without notice.

Warning

Operating frequency:2402MHz – 2480MHz(2.4G only receive)/2402MHz – 2480MHz (BT)
Maximum EIRP Power:5dBm

Declaration of Conformity

GODOX Photo Equipment Co.,Ltd. hereby declares that this equipment are in compliance with the essential requirements and other relevant provisions of Directive 2014/53/EU. In accordance with Article 10(2) and Article 10(10), this product is allowed to be used in all EU member states.

For more information of DoC, Please click this web link:

<https://www.godox.com/eu-declaration-of-conformity/>

The device complies with RF specifications when the device used at 0mm from your body.

FCC Caution

This device complies with part 15 of the FCC Rules. Operation is subject to the following two conditions:

- (1) This device may not cause harmful interference, and
- (2) this device must accept any interference received, including interference that may cause undesired operation.

Any Changes or modifications not expressly approved by the party responsible for compliance could void the

user's authority to operate the equipment.

Note: This equipment has been tested and found to comply with the limits for a Class B digital device, pursuant to part 15 of the FCC Rules. These limits are designed to provide reasonable protection against harmful interference in a residential installation. This equipment generates uses and can radiate radio frequency energy and, if not installed and used in accordance with the instructions, may cause harmful interference to radio communications. However, there is no guarantee that interference will not occur in a particular installation. If this equipment does cause harmful interference to radio or television reception, which can be determined by turning the equipment off and on, the user is encouraged to try to correct the interference by one or more of the following measures:

- Reorient or relocate the receiving antenna.
- Increase the separation between the equipment and receiver.
- Connect the equipment into an outlet on a circuit different from that to which the receiver is connected.
- Consult the dealer or an experienced radio/TV technician for help.

The device has been evaluated to meet general RF exposure requirement.

The device can be used in portable exposure condition without restriction.

IC Warning

Le présent appareil est conforme aux CNR d'Industrie Canada applicables aux appareils radio exempts de licence. L'exploitation est autorisée aux deux conditions suivantes:

- (1) l'appareil ne doit pas produire de brouillage, et
- (2) l'utilisateur de l'appareil doit accepter tout brouillage radioélectrique subi, même si le brouillage est susceptible d'en compromettre le fonctionnement

Tout changement ou modification non expressément approuvé par la partie responsable de la réglementation de l'OCDE peut faire perdre à l'utilisateur le droit d'utiliser l'appareil.

Remarque: cet appareil a été testé pour répondre aux limites des appareils numériques de classe B conformément à la partie 15 des règles de la Federal Communications Commission des États - Unis. Ces limites sont conçues pour fournir une protection raisonnable contre les interférences nuisibles dans les installations résidentielles. L'appareil génère de l'énergie RF utilisée et rayonne, ce qui peut causer des interférences nocives pour les communications radio s'il n'est pas installé et utilisé conformément aux instructions. Cependant, aucun

Garantie contre les interférences dans une installation spécifique. Si l'appareil cause des interférences nuisibles à la réception de la radio ou de la télévision, qui peuvent être déterminées en éteignant et en allumant l'appareil, l'utilisateur est encouragé à tenter de corriger les interférences par une ou plusieurs des mesures suivantes:

- redirection ou repositionnement de l'antenne de réception.
- augmenter l'espacement entre l'appareil et le récepteur.
- Connecter l'appareil à une prise sur un circuit différent de celui auquel le récepteur est connecté.
- consultez votre revendeur ou un technicien radio / tv expérimenté pour obtenir de l'aide.

Avertissement RF pour les appareils portables:

L'appareil a été évalué pour répondre aux exigences générales d'exposition aux radiofréquences. Équipement Peut être utilisé sans restriction dans des conditions d'exposition portables.

产品保修

尊敬的用户，本保修卡是申请保修服务的重要凭证，请您配合销售商填写并妥善保管，谢谢！

产品信息	型号	产品条码
用户信息	姓名	联系电话
	通信地址	
销售商信息	名称	
	联系电话	
	通信地址	
	销售日期	
备注		

注：此表应由销售商盖章确认。

产品信息

本文件适用于相关《产品保修信息》（见后面说明）所列产品，其他非属此范围的产品或部件（如促销品、赠品及其他出厂后附加的部件等）不在此保修承诺内。

保修期

产品及部件的相应保修期按相关的《产品保修信息》执行。保修期自产品首次购买日起算，购买日以购买产品时保修卡登记日期为准。

如何获得保修服务

您可直接与产品销售商或授权服务机构联系，也可拨打神牛产品售后服务电话，与我们联系，由我们的服务人员为您安排服务。申请保修时，您应提供有效的保修卡作为保修凭证，方可获得保修。如您不能提供有效的保修卡，则在我们确认产品或部件属于保修范围的情况下，也可以为您提供保修，但这不作为我们的义务。

不适用保修情况

如产品存在下列情况, 本文件项下的保证和服务将不适用: ①产品或部件超过相应保修期; ②错误或不当使用、维护或保管导致的故障或损坏, 如: 不当搬运; 非按产品合理预期用途使用; 不当插拨外接设备; 跌落或外力挤压; 接触或暴露于不适当温度、溶剂、酸碱、水浸或潮湿环境; ③由非神牛授权机构或人员安装、修理、更改、添加或拆卸造成的故障或损坏; ④产品或部件原有识别信息被修改变更或除去; ⑤无有效保修卡; ⑥使用非合法授权、非标准或非公开发行的软件造成的故障或损坏; ⑦因不可抗力或意外事件造成的故障或损坏; ⑧其他非因产品本身质量问题导致的故障或损坏。遇上述情况, 您应向相关责任方寻求解决, 神牛对此不承担任何责任。因非在保修期或保修范围内的部件、附件或软件导致产品不能正常使用的, 不是保修范围内的故障。产品使用过程中正常的脱色, 磨损和消耗, 不是保修范围内的故障。

产品保修和服务支持信息

产品的保修期和服务类型按以下《产品保修信息》执行:

类别	名称	保修期(月)	保修服务类型
部件	电路板	12	客户送修
其它	例如光效附件、各类线材、航空箱或其他包装	无	无保修

神牛产品售后服务电话 0755-29609320-8062

Warranty

Dear customers, as this warranty card is an important certificate to apply for our maintenance service, please fill in the following form in coordination with the seller and safe-keep it. Thank you!

Product Information	Model	Product Code Number
Customer Information	Name	Contact Number
	Address	
Seller Information	Name	
	Contact Number	
	Address	
	Date of Sale	
Note		

Note: This form shall be sealed by the seller.

Applicable Products

Applicable Products The document applies to the products listed on the Product Maintenance Information (see below for further information). Other products or accessories (e.g. promotional items, giveaways and additional accessories attached, etc.) are not included in this warranty scope.

Warranty Period

The warranty period of products and accessories is implemented according to the relevant Product Maintenance Information. The warranty period is calculated from the day (purchase date) when the product is bought for the first time, and the purchase date is considered as the date registered on the warranty card when buying the product.

How to Get the Maintenance Service

If maintenance service is needed, you can directly contact the product distributor or authorized service institutions. You can also contact the Godox after-sale service call and we will offer you service. When applying for maintenance service, you should provide valid warranty card. If you cannot provide valid warranty card, we may offer you maintenance service once confirmed that the product or accessory is involved in the maintenance scope, but that shall not be considered as our obligation.

Inapplicable Cases

The guarantee and service offered by this document are not applicable in the following cases: ① The product or accessory has expired its warranty period; ② Breakage or damage caused by inappropriate usage, maintenance or preservation, such as improper packing, improper usage, improper plugging in/out external equipment, falling off or squeezing by external force, contacting or exposing to the improper temperature, solvent, acid, base, flooding and damp environments, etc; ③ Breakage or damage caused by non-authorized institution or staff in the process of installation, maintenance, alternation, addition and detachment; ④ The original identifying information of product or accessory is modified, alternated, or removed; ⑤ No valid warranty card; ⑥ Breakage or damage caused by using illegally authorized, nonstandard or non-public released software; ⑦ Breakage or damage caused by force majeure or accident; ⑧ Breakage or damage that could not be attributed to the product itself. Once met these situations above, you should seek solutions from the related responsible parties and Godox assumes no responsibility. The damage caused by parts, accessories and software that beyond the warranty period or scope is not included in our maintenance scope. The normal discoloration, abrasion and consumption are not the breakage within the maintenance scope.

Maintenance and Service Support Information

The warranty period and service types of products are implemented according to the following Product Maintenance Information:

Product Type	Name	Maintenance Period(month)	Warranty Service Type
Parts with electrical properties	Circuit board	12	Customer sends the product to designated site
Other Items	Optical accessories, cables, flight case or other packages, etc.	No	Without warranty

合格证

QC PASS



Wechat
Official Account
神牛微信公众号

深圳市神牛摄影器材有限公司

地址：深圳市宝安区福海街道塘尾社区耀川工业园厂房 2 栋

电话：0755-29609320 (8062) 传真：0755-25723423 邮箱：godox@godox.com

GODOX Photo Equipment Co., Ltd.

Add.: Building 2, Yaochuan Industrial Zone, Tangwei Community, Fuhai Street, Bao'an District, Shenzhen

518103, China Tel: +86-755-29609320(8062) Fax: +86-755-25723423 E-mail: godox@godox.com

www.godox.com

Made in China | 705-P12RP8-00

